

CRIAR E SOLUCIONAR,
A PAIXÃO DE CADA DIA.
IMPROVING SOLUTIONS,
A DAILY PASSION.

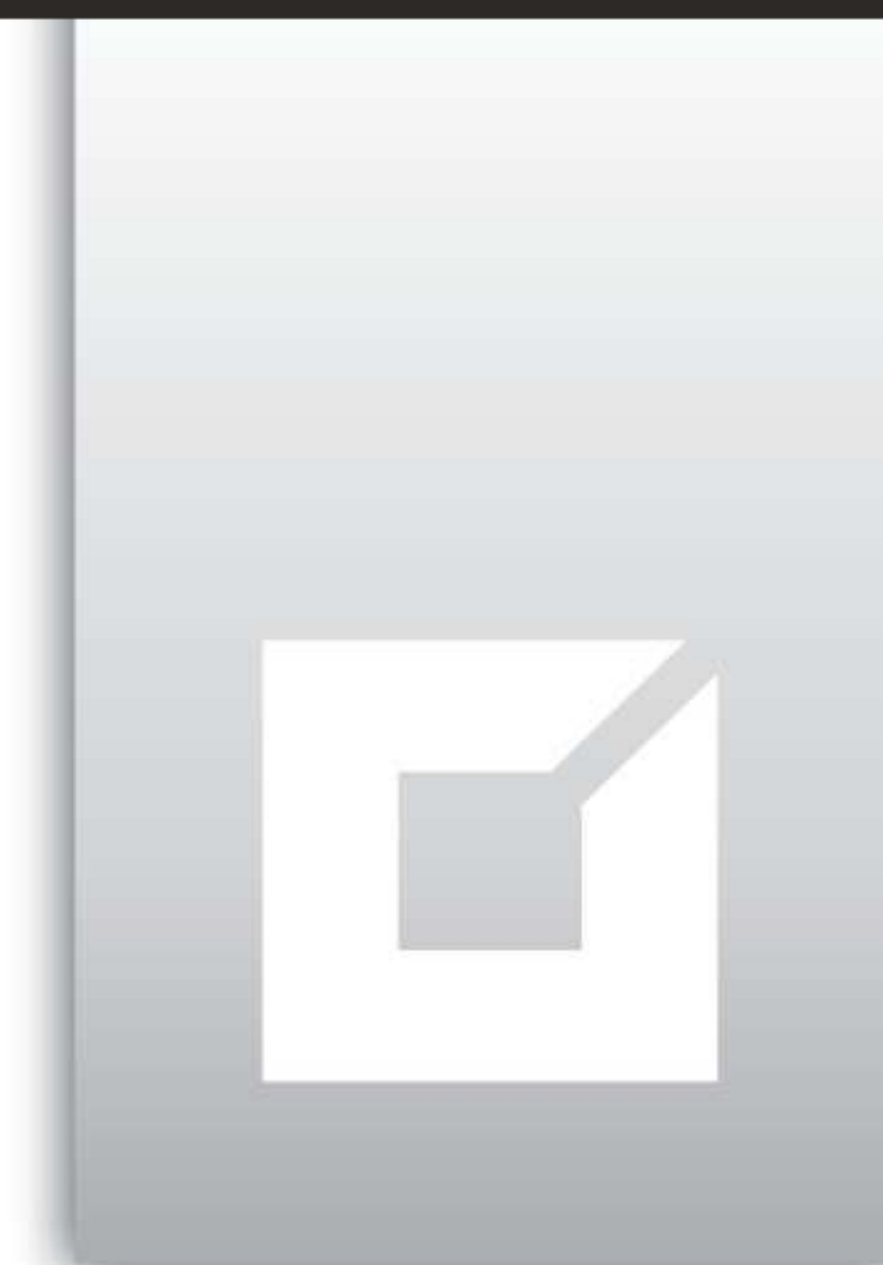

**ENGENHARIA GLOBAL E CONSULTORIA ESPECIALIZADA
PARA O DESENVOLVIMENTO DE PROJETOS DE INFRA-ESTRUTURAS.**

**GLOBAL ENGINEERING AND SPECIALIZED CONSULTING
FOR DEVELOPMENT OF INFRASTRUCTURE PROJECTS.**



Cofinanciado por:



Presente em vários mercados, a **RIPORTICO** é uma Consultora de Engenharia que tem deixado um rasto de serviço a clientes no setor público e privado. As nossas equipas multidisciplinares de técnicos especializados com provas dadas colocam Paixão, Atitude e Competência na procura das melhores soluções para os nossos clientes.

A credibilidade da nossa presença nos mercados e nas áreas de engenharia confunde-se com a competência local que agregamos nas nossas equipas e com a proximidade que queremos ter com cada cliente.

Present in many markets, **RIPORTICO** is an Engineering Consultant Company who has left a trail of service to clients in the public and private sectors. Our multidisciplinary teams of technical experts with proven skills put passion, attitude and competence in finding the best solutions for our customers.

The credibility of our presence in different international markets and in engineering in general is intertwined with the local expertise we add in each of our teams. Through this we achieve a unique intimacy with all of our clients.



TRANSPORTES
TRANSPORTATION



ENERGIA
POWER



HIDRÁULICA
WATER



CONTROLO DE QUALIDADE
QUALITY CONTROL



AMBIENTE
ENVIRONMENT



EFICIÊNCIA ENERGÉTICA
ENERGY EFFICIENCY



EDIFICAÇÃO
BUILDINGS



INDÚSTRIA
INDUSTRY

ENGENHARIA
GLOBAL...
GLOBAL ENGINEERING...

Cofinanciado por:



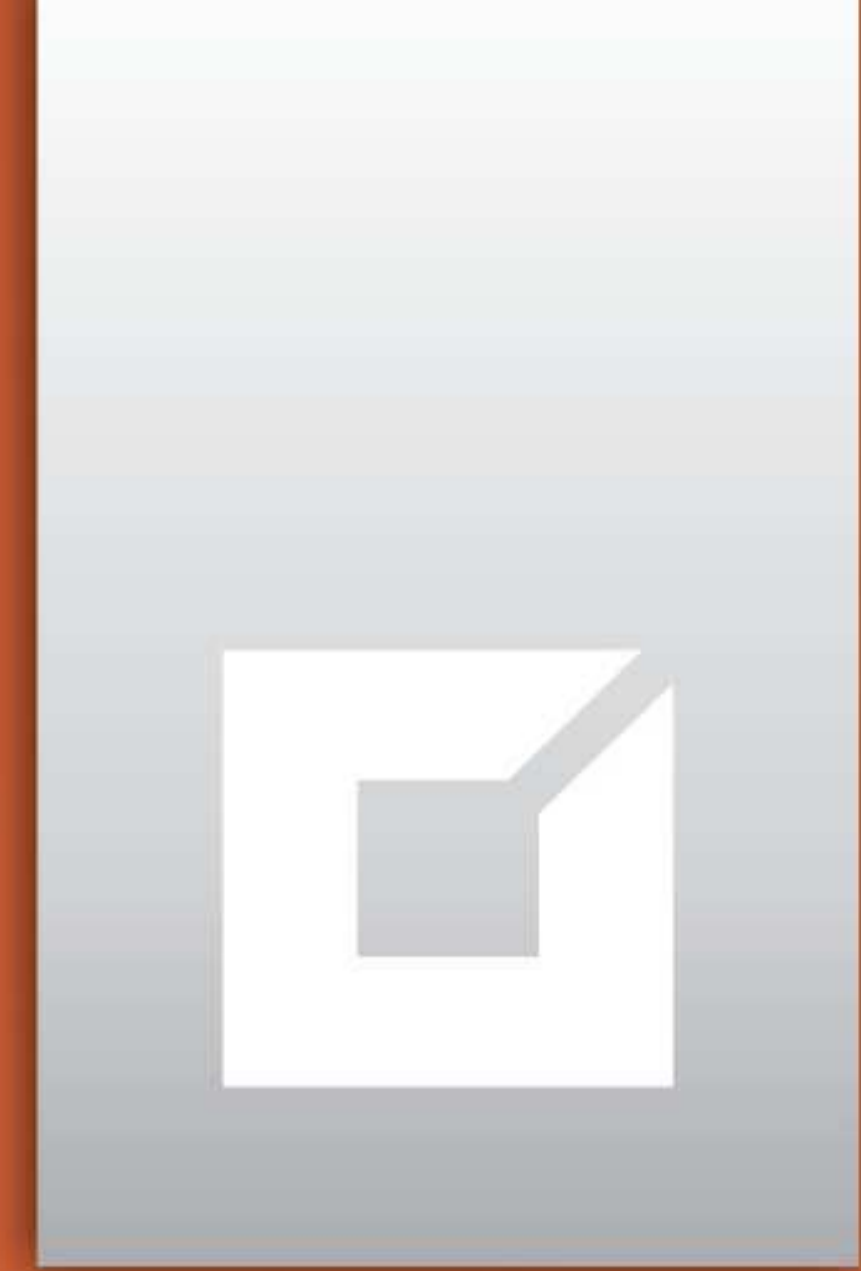

ONDE ESTAMOS

WHERE WE ARE...



BRASIL | SÃO PAULO [Sede]

Av. Paulista 2073
17º andar Conj. 1702
01311-300 | São Paulo
T. (11) 3373-7453
F. (11) 3373-7510
br@riportico.com

MOÇAMBIQUE | MAPUTO [Sede]

[HEADQUARTERS]
Rua de França n.º72
3º andar, Porta 8
Caixa Postal 940 - Maputo | Moçambique
t. +258 840 31 2820 | +258 827 00 4483
f. +258 21 415611
mz@riportico.com

BULGÁRIA | SOFIA [Sede]

[HEADQUARTERS]
Rajon ILINDEN
ZH. K. "SVETA TROICA" | Sofia
Bl 302; vh. B; et 6; ap.39
t. +359 89 91 09243
bg@riportico.com

PORTUGAL | VISEU [Sede]

[HEADQUARTERS]
Rua Viriato, 161 3430-649
Cabanas de Viriato | Portugal
t. +351 232 691 707
f. +351 232 691 144
geral@riportico.com

PORTUGAL | LISBOA [Filial]

Av. João Crisóstomo, 233 5º
1050- 127 Lisboa | Portugal
t. +351 21 330 860
f. +351 21 330 733

CABO VERDE | PRAIA [Sede]

[HEADQUARTERS]
Rua Ilha do Maio, 1 - 3º
CP 442-A Praia | Cabo Verde
t. +238 262 0168
f. +238 262 0169
caboverde@riportico.com

SIERRA LEONE | FREETOWN [Sede]

[HEADQUARTERS]
64 Pademba Road
Opposite Upper Waterloo Str
Freetown | Sierra Leone
t. +232 77 719 772
sl@riportico.com

WWW.RIORTICO.COM

CRIAR E SOLUCIONAR, A PAIXÃO DE CADA DIA.

IMPROVING SOLUTIONS, A DAILY PASSION.

RIORTICO
ENGENHARIA

Cofinanciado por:



STUDIES AND DESIGN PROJECTS

Over the years the Project Department at RIPORTICO has gathered experience elaborating studies and design projects related to virtually every field of the construction industry.

At RIPORTICO we develop studies and design projects for:

Roads, Bridges, Tunnels, Railways.

Hospital Buildings, Homes, Public Buildings, Hotels, Shopping Centres, Banks, Schools, Police Stations and Rehabilitation of Antique Buildings.

Renewal of urban spaces, such as avenues and landscaping.

Acoustic studies of auditoriums and other interior spaces and improvement of building energy efficiency.

Water supply, sewage treatment plants and waste water recovery systems.



RIPORTICO developed 90% of the design projects for all the roads built in the last five years by the Cape Verdean Government.

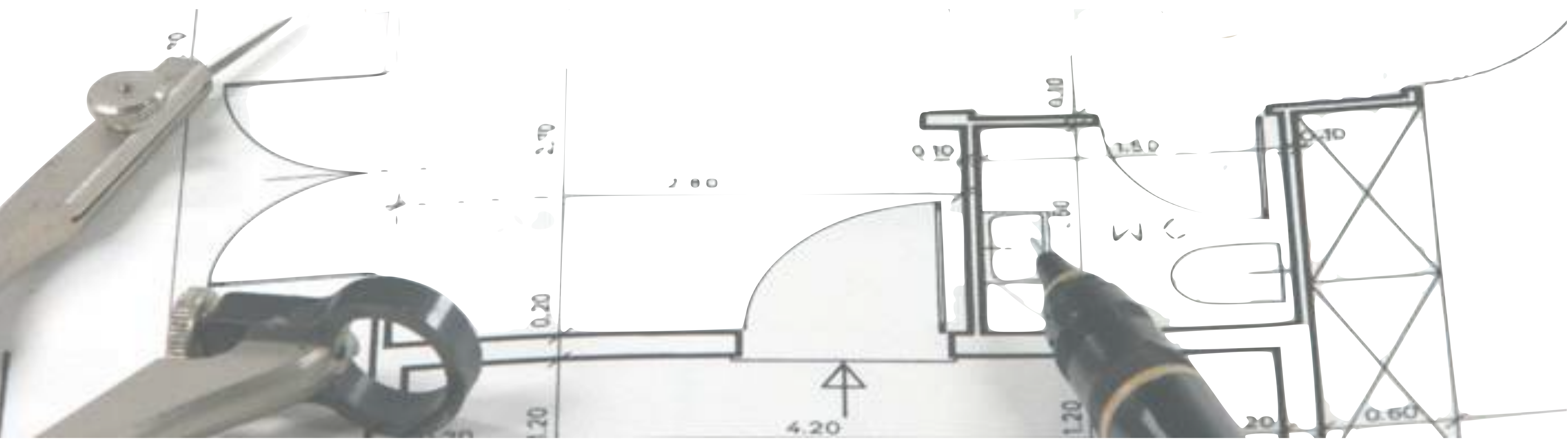

We Guarantee Competence, Precision and Integrity

WWW.RIPORTICO.COM

Cofinanciado por:



RIPORTICO

INNOVATION AND DEVELOPMENT (I&D) FOR A SUSTAINABLE CONSTRUCTION

Innovation and development are the engineering and architectural response to the status quo concerning technical standards that are repeated throughout time without improvement or questioning.

RIPORTICO and its consultants, designers and project managers seek to develop and innovate solutions for today and the future in the form of more sustainable and appropriate construction methods that make more sense.

One of RIPORTICO's I&D success stories is the promotion of high energy efficiency bioclimatic architecture design projects.

The interaction between different engineering disciplines and their interconnection with passive design concepts resulted in models that have been tested by simulators over many years and calculation models that today translate into lower energy consuming buildings.

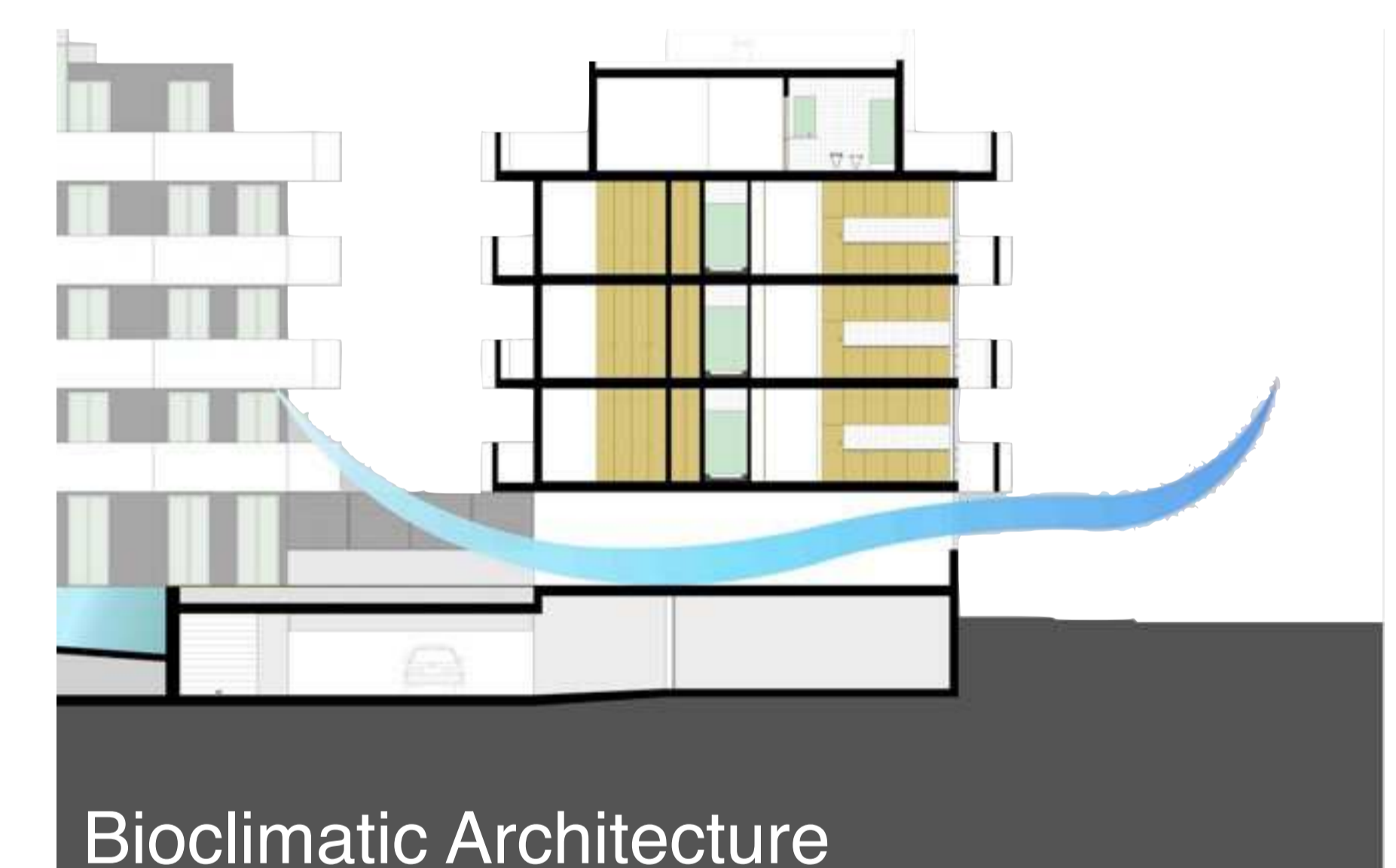

At RIPORTICO we design environment friendly buildings protecting the future of the planet at no significant increase in cost.

We Guarantee Competence, Precision and Integrity

WWW.RIPORTICO.COM

Cofinanciado por:



RIPORTICO

SITE SUPERVISION

Acting as the client's technical support system, RIPORTICO takes care of the contract from a management and financial point of view promoting cost control through contract measurement reports, current accounts, technical advice, scheduling meetings and tours with the stakeholders, all the while preparing daily progress reports and monitoring project planning, taking measures as to avoid mission creep and recovering from delays, supervising all the tasks on site, guaranteeing the excellence of the works' outcome.

RIPORTICO's site supervision service has secured demanding clients over recent years, through implementation of a control system where specific and intense training programmes have led to differentiating results.

At RIPORTICO we allocate a multidisciplinary team with resident engineers on-site ready to meet the demands in the following segments of the mission, for any client:

- A – Administration of Contracts**
- B – Execution Supervision**
- C – Quality Control**
- D – Construction Safety**
- E – Environmental Management**

Works that stick to their original cost, are completed on time and are handed over to the client with the expected quality.



S Nicolau Island Road, Cape Vert



Public Building IEFP, Portimao



Rio Sorraia Dam



We Guarantee Competence, Precision and Integrity

WWW.RIPORTICO.COM

Cofinanciado por:



UNIÃO EUROPEIA
Fundo Europeu
de Desenvolvimento Regional



RIPORTICO



INDUSTRY | DISTRIBUTION | LOGISTICS | TOURISM | HEALTH SPORT | REAL ESTATE

In order for the client to be able to concentrate fully on the most important part of its business, RIPORTICO takes care of our client's infrastructure.

The technical counsel at RIPORTICO supports the investor in all the necessary phases of construction by setting the most advantageous strategy and the most sound planning, seeking to achieve viable projects whilst reducing costs and optimizing sustainability and resources with targeted action plans and contract management.

We support anyone who wants to invest in making the right choices, studying the viability of solutions and developing design projects and studies through creating reliable procurement processes for constructors and equipment suppliers. We plan, supervise and coordinate actions of all of those involved up to the time of utilisation.



Intermarché, Canedo



Jose Peseiro Municipal Stadium

**Planning, Strategy, Programming, Design Projects,
Viability, Licensing, Cost Reduction, Construction,
Equipment, Supervision, Utilisation.**

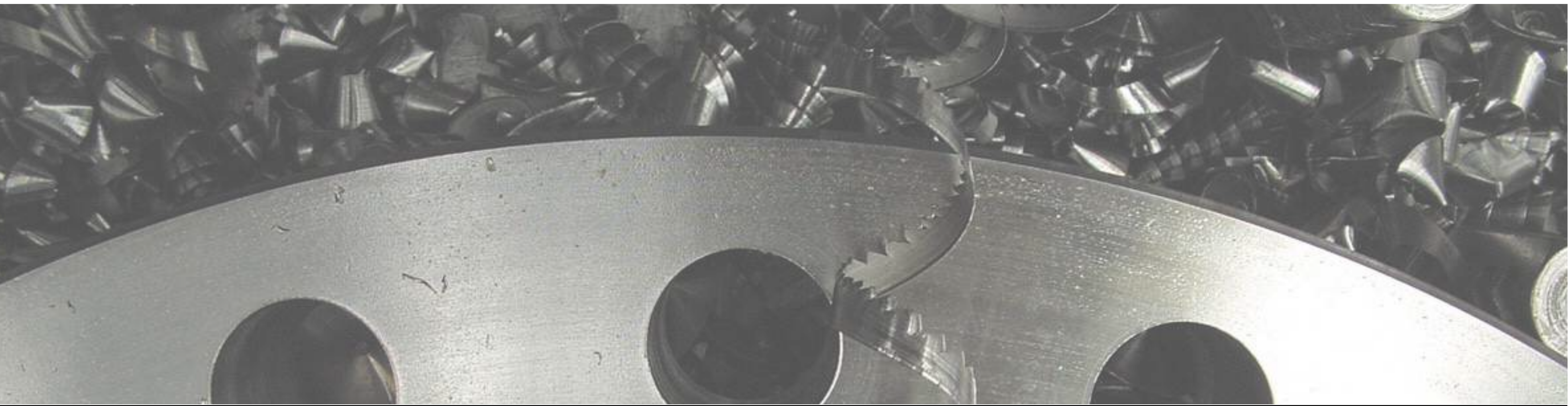

We Guarantee Competence, Precision and Integrity

WWW.RIPORTICO.COM

Cofinanciado por:



RIPORTICO



INDUSTRY | DISTRIBUTION | LOGISTICS | TOURISM | HEALTH SPORT | REAL ESTATE

With competence, attitude and proximity, we design solutions tuned to the needs of each client based on the following phases of consulting:

Strategy

- Global Analysis of General and Specific Objectives
- Diagnostic Site Studies, Needs and Necessities, etc.
- Cost Projections
- Option Negotiation

Design

- Design and Implementation Studies
- Equipment Studies
- Research
- Financial Feasibility Studies
- Preliminary Engineering Studies (Geotechnical and Topographical)
- Licensing Projects
- Licensing
- Financial Projects
- Detailed Design

Procurement

- Supplies and Subcontract Acquisition Processes
- Proposal Analysis and Decision Support Reports

Construction

- Management and Construction Supervision
- Site Safety Coordination
- Environmental Management

Utilisation

- Preparation and Reception of Contracts
- Utilisation Licenses
- Manuals, Certificates and Equipment
- Maintenance Contracts



Industrial



Sports Area



Health Center



Shopping

We Guarantee Competence, Precision and Integrity

WWW.RIORTICO.COM

Cofinanciado por:



RIPORTICO

SAFETY

Health and safety are of extreme importance to RIPORTICO, to provide a secure and humane work place. The construction industry deserves to be treated in a special way due to the high index of work related accidents and the nature of work with relevant risks worth evaluating in terms of avoiding worker exposure to danger.

At RIPORTICO, as far as safety goes, we ensure:

Health and Safety Plans that are implemented from the design stage to work phase to ensure quality and safety control.

We use **Health and Safety Coordination** and safety management systems on site linking and matching the action of all parties, checking incompatible activities, foreseeing implementation of adequate measures to comply with the safety plan.



Protecting the life and health of workers in an Industry with a high rate of work related accidents.

We Guarantee Competence, Precision and Integrity

WWW.RIPORTICO.COM

Cofinanciado por:



RIPORTICO

SPECIALIZED CONSULTANTS

At RIPORTICO when we speak of global engineering we do not only intend to highlight the position we have achieved in varied markets and countries, but also the all-encompassing know-how of our specialised consultants and technical staff, whichever the type of infrastructure.

Responding to the major challenges of engineering we provide our clients with proven experienced technicians, guaranteeing viable and customized solutions.



ies, Champalimaud Foundation, Lisbon



tunneling, Coruche's Emissary

RIPORTICO'S know-how and technical accuracy of its consultants are fundamental keys to support the client's decision.

We guarantee Competence, Precision and Integrity.

WWW.RIPORTICO.COM

Cofinanciado por:

CENTRO 2020

PORTUGAL 2020

UNIÃO EUROPEIA
Fundo Europeu
de Desenvolvimento Regional



RIPORTICO

SPECIALIZED CONSULTANTS

At RIPORTICO when we speak of global engineering we do not only intend to highlight the position we have achieved in varied markets and countries, but also the all-encompassing know-how of our specialised consultants and technical staff, whichever the type of infrastructure.

Responding to the major challenges of engineering we provide our clients with proven experienced technicians, guaranteeing viable and customized solutions.



ies, Champalimaud Foundation, Lisbon

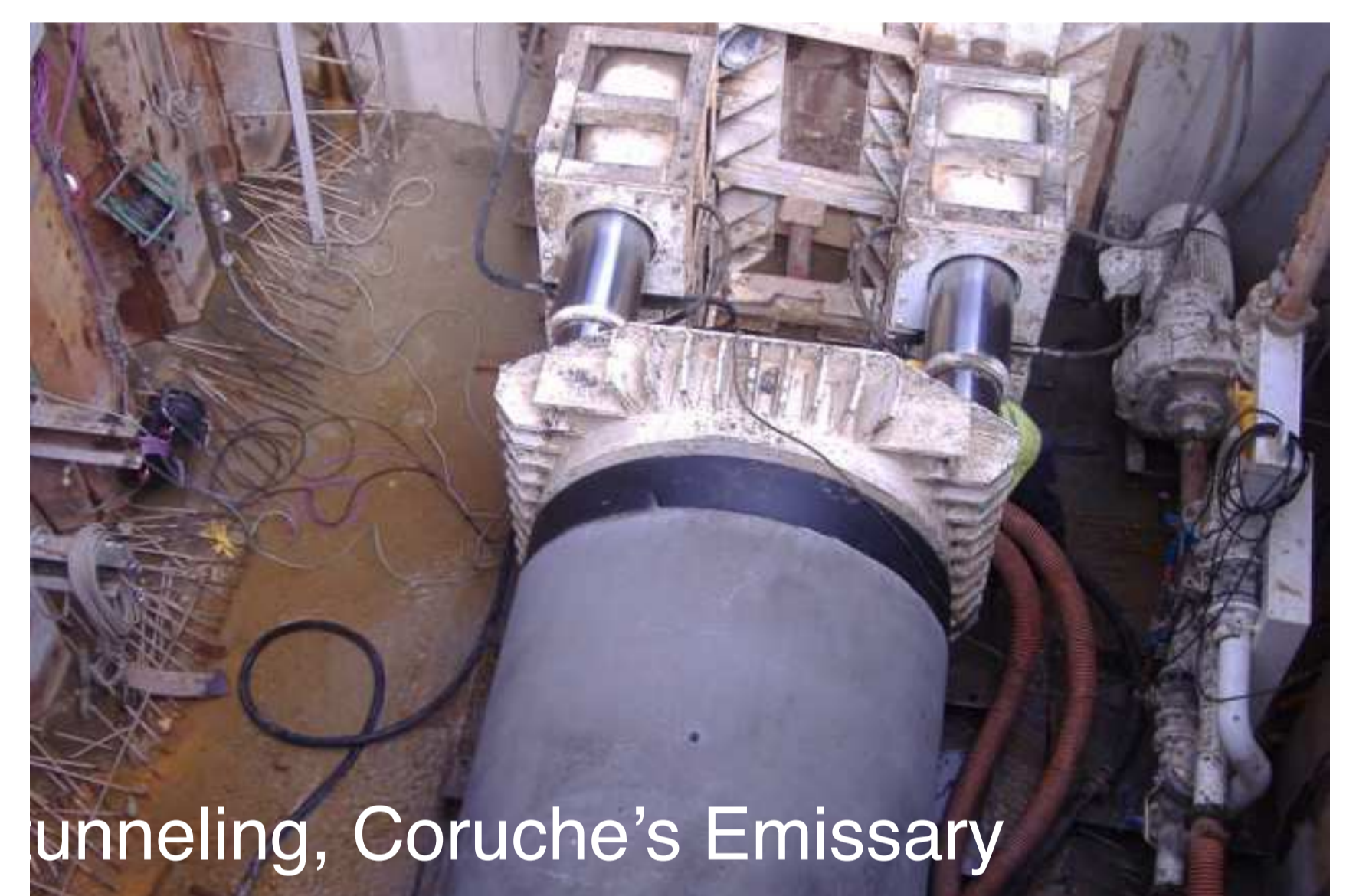

tunneling, Coruche's Emissary

RIPORTICO'S know-how and technical accuracy of its consultants are fundamental keys to support the client's decision.

We guarantee Competence, Precision and Integrity.

WWW.RIPORTICO.COM

Cofinanciado por:

CENTRO 2020

PORTUGAL 2020

UNIÃO EUROPEIA
Fundo Europeu
de Desenvolvimento Regional



RIPORTICO

PROJECT MANAGEMENT

Project management covers the overall management of the construction process bringing together disciplines such as engineering, architecture, management, economics and law.

RIPORTICO provides the client with specialised counsel during all phases of the project, from defining the strategy, financial projects, execution projects, licencing, legal advice and procurement processes, planning, to construction and utilisation.



A partnership with RIPORTICO ensures that the investor gets the project delivered on time with controlled costs and guaranteed quality.



We guarantee Competence, Precision and Integrity.

WWW.RIPORTICO.COM

Cofinanciado por:

CENTRO 2020

PORTUGAL 2020



RIPORTICO

ENVIRONMENTAL MANAGEMENT

Environmental management in construction is key to reducing environmental impacts. In this sense RIPORTICO's teams ensure implementation of rigid routine inspections, surveying of non-conformities and corrective action and verification of checklists given the environmental licenses' demands and constraints.

With the evolution and substantiation of our clients' projects, RIPORTICO promotes the preparation of reports and constant supervision of conformity with the environmental licences.



Because the planet is our home

We Guarantee Competence, Precision and Integrity

WWW.RIPORTICO.COM

Cofinanciado por:

CENTRO 2020

PORTUGAL 2020

UNIÃO EUROPEIA
Fundo Europeu
de Desenvolvimento Regional



RIPORTICO

GEOTECHNICS AND QUALITY CONTROL

In order to reach excellence in our services, RIPORTICO understands the need for its own laboratory outfitted with the necessary equipment for the research and verification of design solutions, quality control and monitoring of construction processes.

Today, supporting all other departments, RIPORTICO has a geotechnical and quality control department dedicated to undertaking geotechnical engineering lab work and on site tests. These are important tools in understanding material characteristics and underground properties, as well as undertaking tests on concrete, aggregates and bituminous mixtures.

RIPORTICO provides topographical services for developing surveys used in design projects, but primarily on site during site supervision.

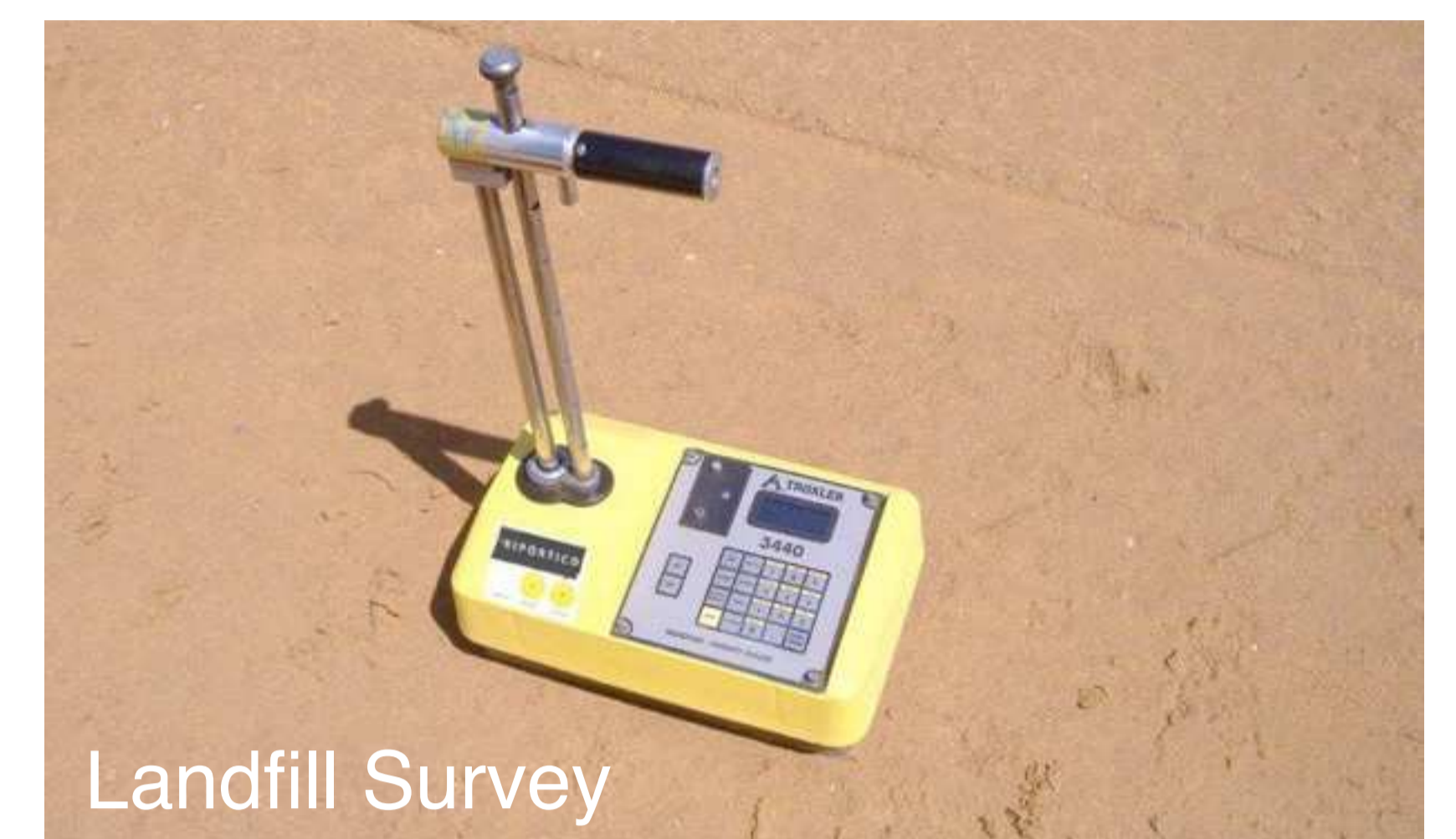

Landfill Survey



Concrete Tests



Topographical Survey

We control all details, no matter how big or small.

We Guarantee Competence, Precision and Integrity

WWW.RIPORTICO.COM

Cofinanciado por:

CENTRO 2020

PORTUGAL 2020



UNIÃO EUROPEIA
Fundo Europeu
de Desenvolvimento Regional



RIPORTICO